

1. ALL DIMENSIONS ARE IN mm WITH ± 0.20 TOLERANCE UNLESS OTHERWISE SPECIFIED.
2. VIEWING ANGLE: 6:00 O'CLOCK.
3. VIEWING MODE: POSITIVE, REFLECTIVE
4. DISPLAY TYPE: TN
5. CONNECTOR: PIN
6. FLUID SPECIFICATION:

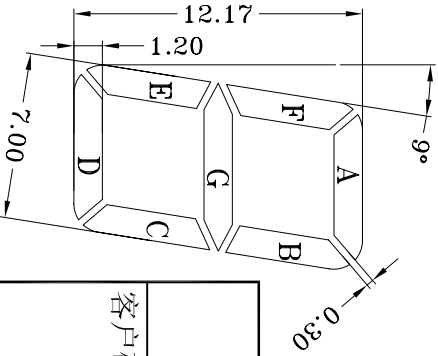

厦门精显电子有限公司
XIAMEN PRECISE DISPLAY CO., LTD.

客户确认:

绘图: 何健

绘图编号: GYTN2170

单位: mm

审核: 朱从记

客户编号:

日期: 2005.10.12

批准: Yan

图纸版号: 01

页数: 1/3

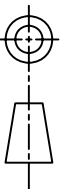

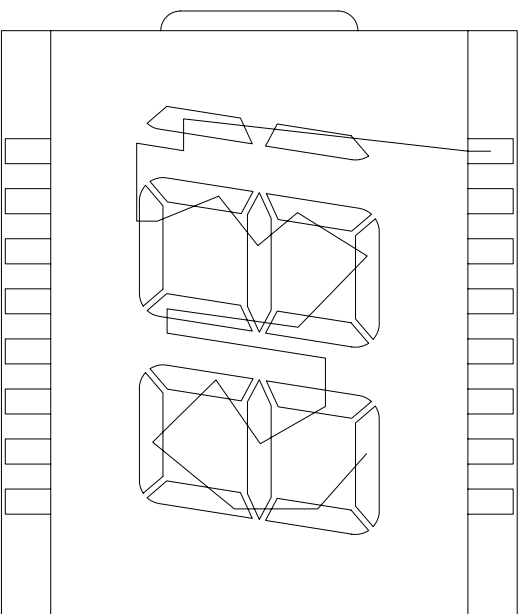
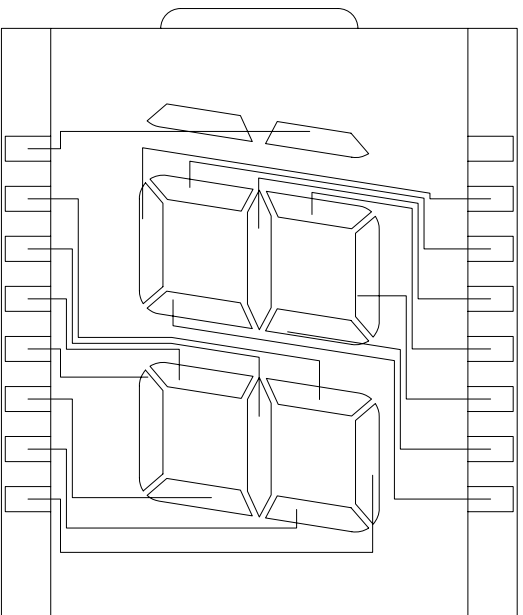

SEGMENT

COMMON

PIN	1	2	3	4	5	6	7	8
SEG	1BC	3F	3G	3E	3D	3C	3B	3A
PIN	9	10	11	12	13	14	15	16
SEG	2C	2B	2A	2F	2G	2E	2D	COM

 厦门精显电子有限公司
XIAMEN PRECISE DISPLAY CO., LTD.

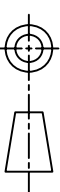

客户确认:

绘图: 何健

绘图编号: GYTN2170

单位: mm

审核: 朱从记

客户编号:

日期: 2005.10.12

批准: yan

图纸版号: 01

页数: 2/3

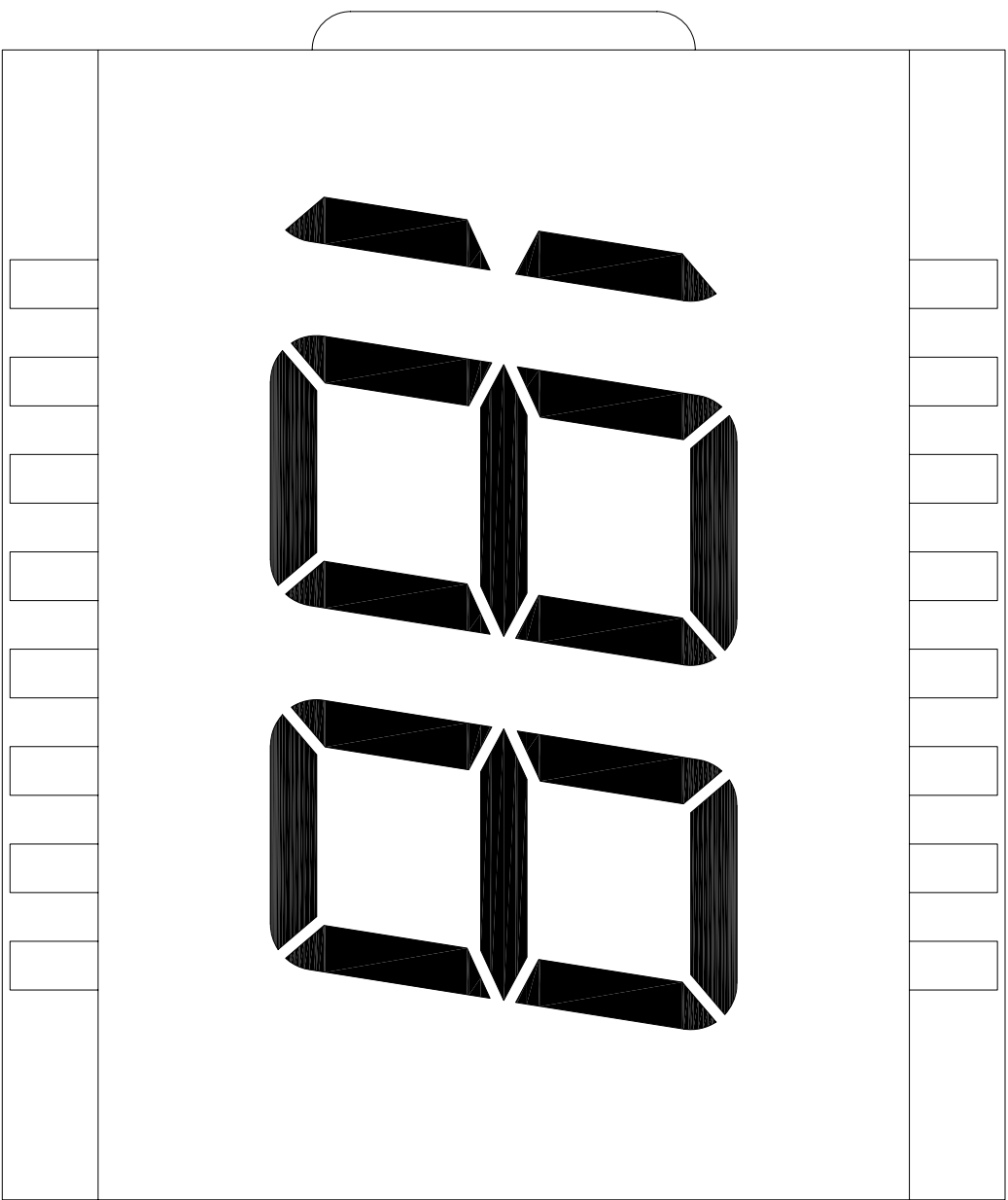

1:1

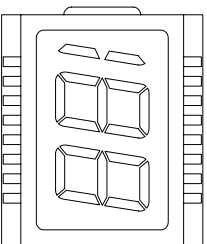

 厦门精显电子有限公司 XIAMEN PRECISE DISPLAY CO., LTD.		客户确认:			
		绘图: 何俊 审核: 朱从记 批准: yan	绘图编号: GYTN2170 客户编号:	单位: <i>mm</i> 日期: 2005.10.12 页数: 3/3	