

PIN	1	2	3	4	5	6	7	8	9	10	11	12	13	14	15	16	17	18	19	20
SEGCOM	X2	X4	X7	X8	X6	X9	DP1	1E	1D	1C	DP2	2E	2D	2C	DP3	3E	3D	3C	3B	
PIN	21	22	23	24	25	26	27	28	29	30	31	32	33	34	35	36	37	38	39	40
SEG	3A	3F	3G	2B	2A	2F	2G	COL	1B	1A	1F	1G	NC	NC	NC	X5	X10	X1	X3	COM

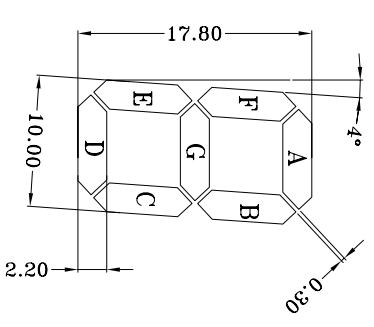

1. ALL DIMENSIONS ARE IN mm WITH ± 0.20 TOLERANCE UNLESS OTHERWISE SPECIFIED.
2. VIEWING ANGLE: 6:00 O'CLOCK.
3. VIEWING MODE: POSITIVE, REFLECTIVE
4. DISPLAY TYPE : TN
5. CONNECTOR: PIN
6. FLUID SPECIFICATION:
 - DRIVING VOLTAGE: 5.0V
 - MULTIPLY LEVEL: STATIC
 - OPERATING TEMP. : -30°C -- +85°C
 - STORAGE TEMP. : -30°C -- +85°C

厦门精显电子有限公司
 XIAMEN PRECISE DISPLAY CO., LTD.

客户确认:		绘图: 何斌 审核: 高峰 批准: Yan	
绘图编号: GYTN2034 客户编号:		单位: mm 日期: 2005.09.01 页数: 1/3	

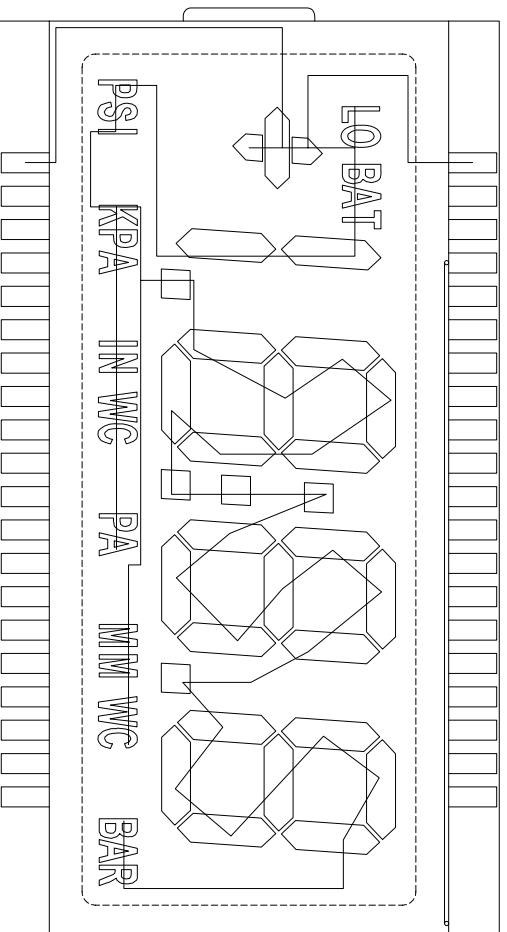
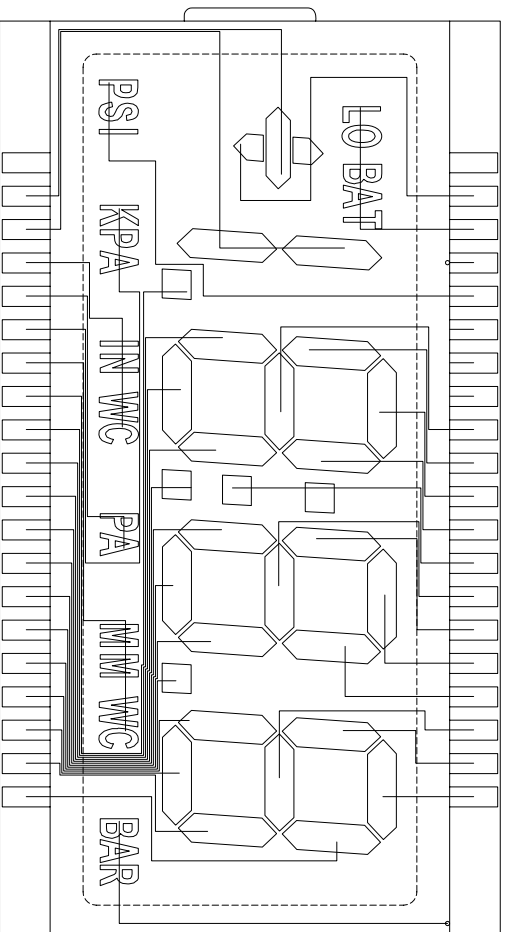

SEGMENT

COMMON



厦门精显电子有限公司
XIAMEN PRECISE DISPLAY CO., LTD.

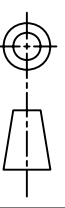

客户确认:

绘图: 何斌

绘图编号: GYTN2034

单位: mm

审核: 高峰

客户编号:

日期: 2005.09.01

批准: Yan

图纸版号: 01

页数: 2/3

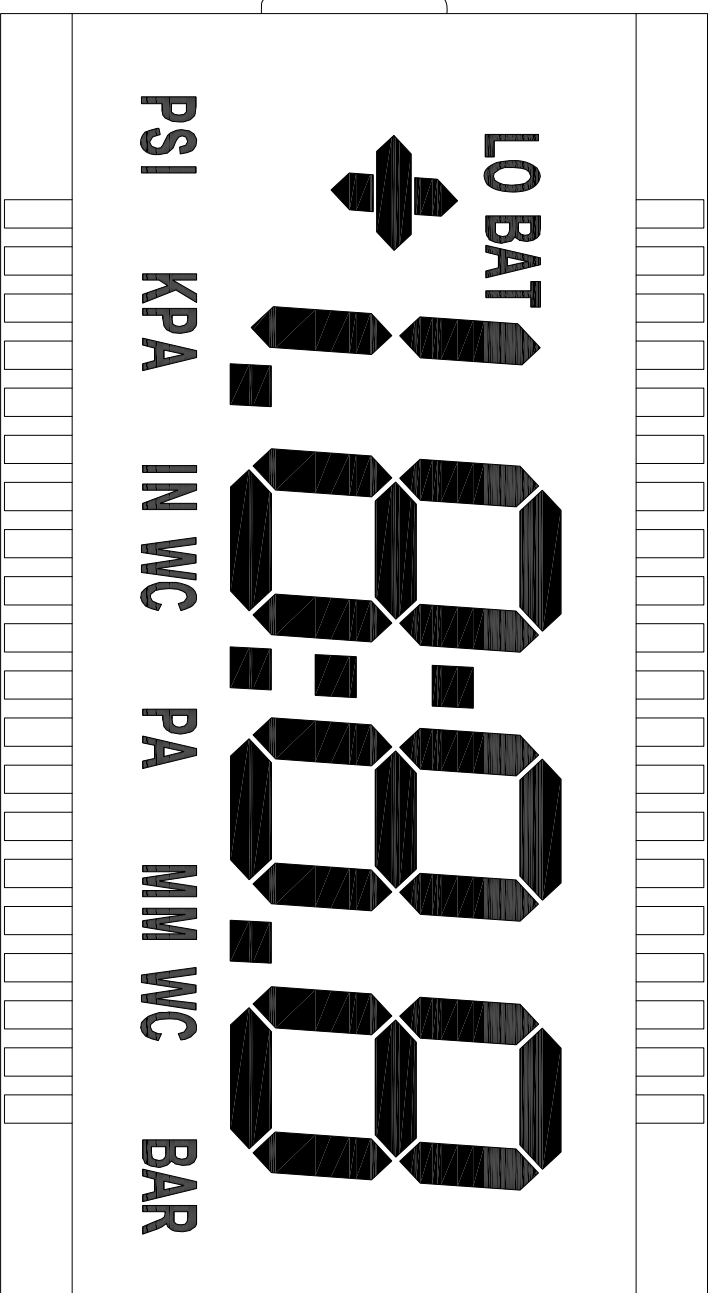

1:1

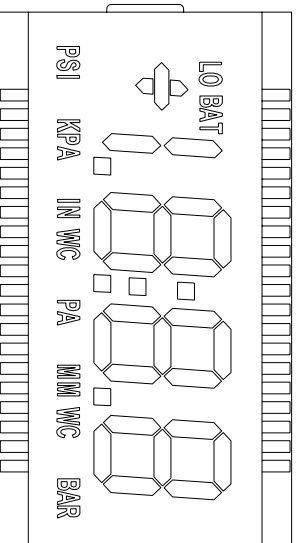

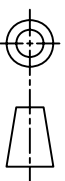
 厦门精显电子有限公司 XIAMEN PRECISE DISPLAY CO., LTD.			
绘图: 何俊	审核: 高峰	批准: yan	
绘图编号: GYTN2034	客户编号:	图纸版号: 01	
单位: mm	日期: 2005.09.01	页数: 3/3	